

Varenummer: 20088365

Beskrivelse: E+G Bøjlegreb GN 565.4-20-192-B-SW

Mål

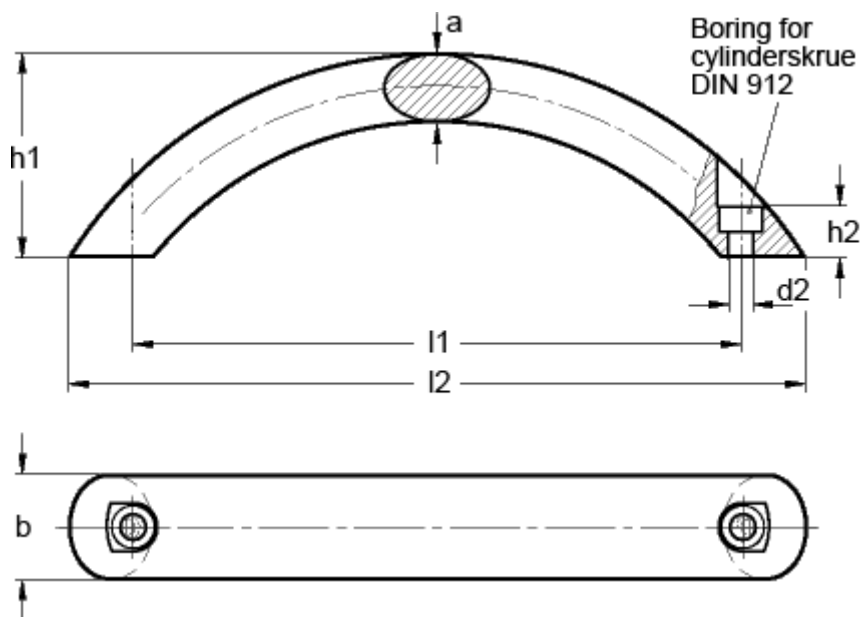

a	= 13
b	= 20
d2	= 5.3
h1	= 51
h2	= 10
l1	= 192
l2 ca.	= 221
t min	= 8.5